

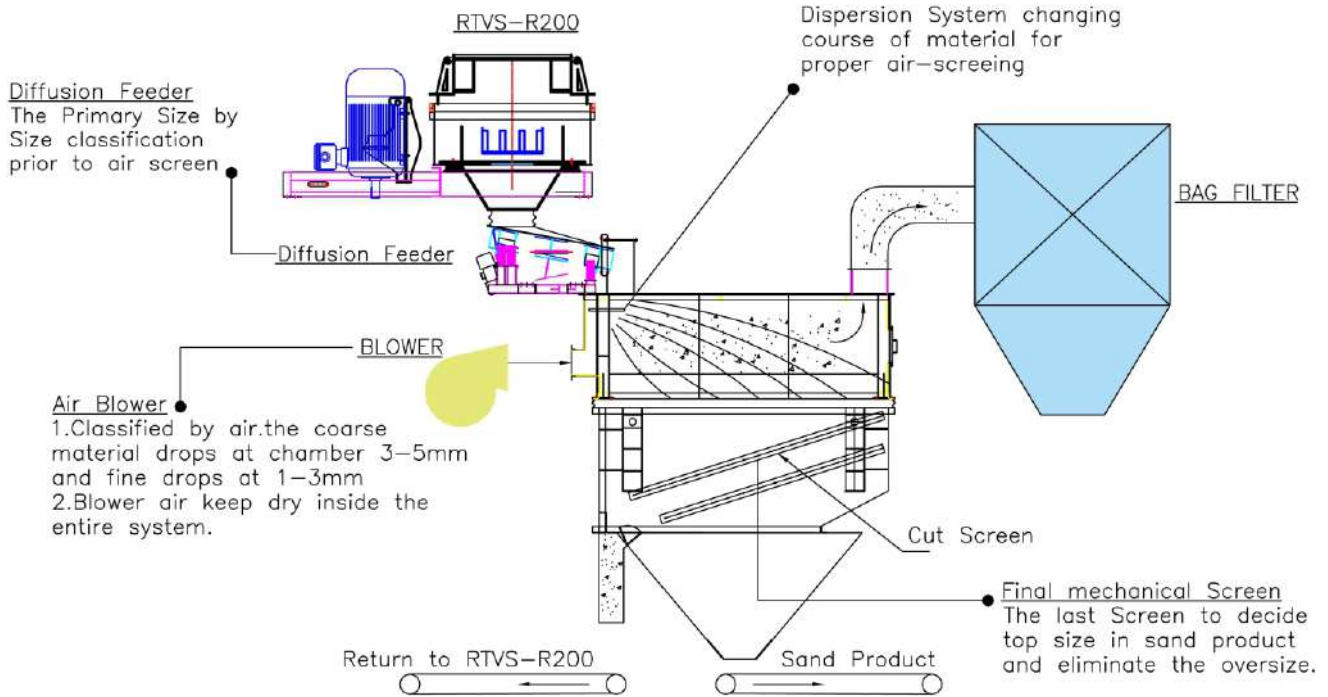

# ROCKTECH ECO FRIENDLY SAND PLANT



“Rock Revolution by Rocktech”

[www.rocktechengineers.com](http://www.rocktechengineers.com)

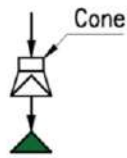
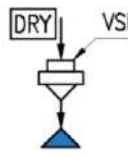
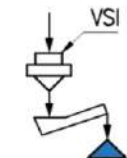
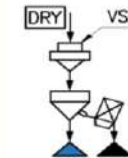

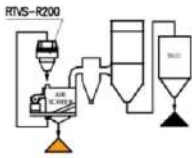
Sr. No.	Sand Quality	Sand Made by Cone Crusher	Sand Made by VSI Machine	Sand Made by VSI + Screw Washed Sand	Sand Made by VSI + Classifier Washed Sand	Natural River Sand	Sand Made by Rocktech ECO-Sand Plant
1	Overall Grading	★★	★★	★★	★★	★★★★★ May Vary	★★★★★ Precise Control
2	Cleanliness/ Ultra-fines Control	★★ Dusty	★ Dusty	★★	★★★	★★★★★	★★★★★ Precise Control
3	FM (Fineness Modulus)	★ Very Coarse	★★ Less Coarse	★★ Very Coarse	★★	★★★★★ May Vary	★★★★★ Precise Control
4	Shape	★ Very Flaky	★ Less Flaky	★ Less Flaky	★	★★★★★	★★★★★
5	Process Chart						

Sr. No.	Model	Power (kW)	Capacity (TPH)
1	RT-ECO-40C	240	40
2	RT-ECO-70C	380	70

- Notes:**
- The capacity is indicative for producing crushed sand to be used as a single sand component for aggregate and when materials having bulk density of 1.6 t/m<sup>3</sup> are constantly supplied.
  - Processing capacity varies subject to stone quality and size of the material.
  - Consumed power to be lower depending on material properties.
  - Moisture content of the feed materials is 2 % or less .



### **ADVANTAGES :**

- Ideal Grain Shape and Size.
- Low Operating Cost.
- Controlled Fineness Modulus.
- Environment Friendly.
- Flexibility to produce desired Grade Sand.
- Controlled Moisture Content.





### Factory

Unit: 01

#### **ROCKTECH ENGINEERS**

Sy. No. 58/3/2A, Gatesh Khurd,  
Shirishpada-Khanivali Road,  
Tal. Wada, Dist. Palghar,  
Maharashtra-421303

Ph: +91-02526-212140

+91-9552696089

[info@rocktechengineers.com](mailto:info@rocktechengineers.com)

Unit: 02

#### **ROCKTECH ENGINEERS**

Sy. No. 210, Jamghar, Near Bharat Gas  
Godown, Shirishpada-Khanivali Road,  
Tal. Wada, Dist. Palghar,  
Maharashtra-421303

Ph: +91-9890758562

[rocktechengineers@rediffmail.com](mailto:rocktechengineers@rediffmail.com)

### Follow us



@ rocktechengg



@ Rocktech Engineers



@ Rocktech Engineers